

April 14, 1942.

A. R. VISITACION

2,279,803

SECURITY CLIP

Filed June 6, 1941

Fig. 1.

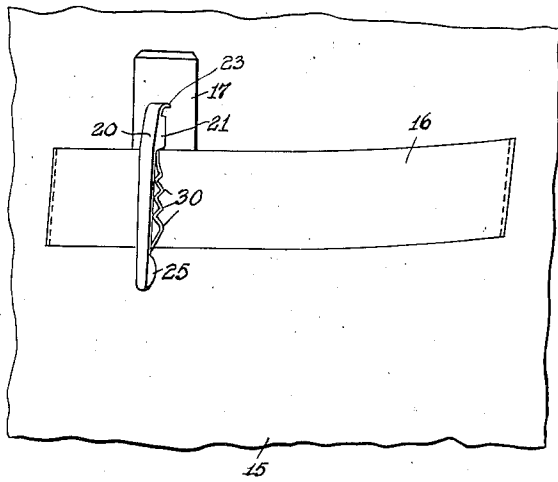

Fig. 2.

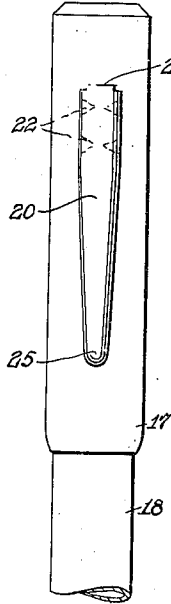

Fig. 3.

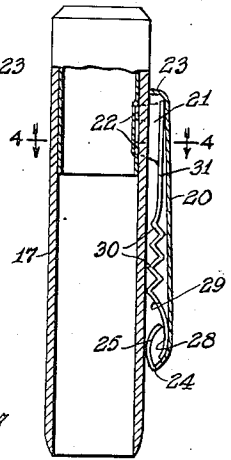

Fig. 4.

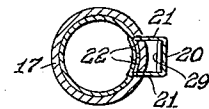

Fig. 5.

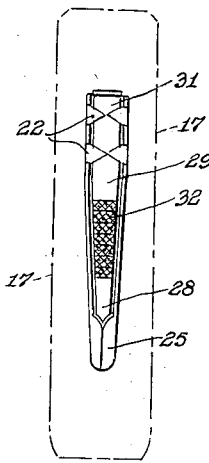

Fig. 6.

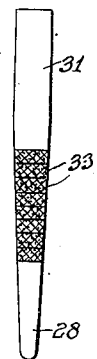

Fig. 7.

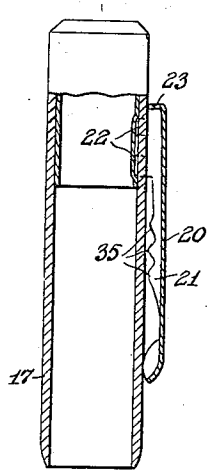

Fig. 8.

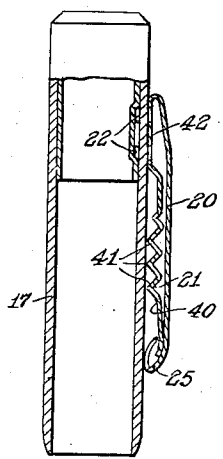
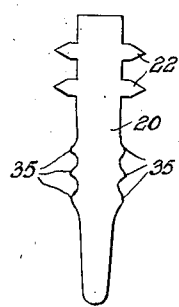

Fig. 9.



INVENTOR.
ANICETO R. VISITACION

BY

Warren E. Willis.
ATTORNEY.

UNITED STATES PATENT OFFICE

2,279,803

SECURITY CLIP

Aniceto R. Visitacion, New York, N. Y.

Application June 6, 1941, Serial No. 396,827

1 Claim. (Cl. 24—11)

This invention relates to pocket carried implements, and more particularly to the clips used to prevent them from becoming loosened and lost.

The usual type of clip consists of a strip of spring metal, fixedly engaged at one end to the body, or cap, of the implement, to extend alongside, and terminate in a nodula hump, disposed outside the pocket.

This arrangement permits the implement to sway in the pocket, by pivoting on the hump, and, as the hump is smoothly rounded, fails to provide such secure gripping effect as is desirable.

Having this matter in mind, it is an object to provide a clip that can be relied upon to retain an article to which it is affixed, safely and securely in a pocket, preventing it from side swaying or swinging movement.

Another purpose is to produce a clip having a concealed, undulated spring strip, provided with defined corrugations adapted to forcibly grip the pocket material, assuring positively safe maintenance, until the application of force in its withdrawal.

These valuable features, together with inexpensive construction, ease of application and long continued service, are accomplished by the novel and practical construction and arrangement of simple parts, hereinafter described and illustrated in the accompanying drawing, constituting a graphical component of this disclosure, and in which:

Figure 1 is a fragmentary view of a conventional pocket showing an application of the invention.

Figure 2 is an enlarged front view of the clip as attached to a pen cap.

Figure 3 is a longitudinal sectional view of the same.

Figure 4 is a transverse sectional view looking on line 4—4 of Figure 3.

Figure 5 is a rear view of the clip.

Figure 6 is a detail view of the serrated member.

Figure 7 is a view similar to Figure 3, but showing a modification in construction.

Figure 8 is another like view showing a further modified construction.

Figure 9 is a plan view of the blank from which the clip in Figure 7 is formed.

In Figure 1 of the drawing, a fragmentary portion of a garment is designated by the numeral 15, having a pocket, as indicated by the bar 16, above which protrudes the cap 17 of a writing

implement 18, as the fountain pen shown. This is, however, to be regarded only as suggestive, rather than restrictive, of the types of pocket carried articles to which the clip may be applied.

Such clips are attached to an object by any preferred means, as encircling bands, in-set rings, in-bent or out-turned prongs, etc. which form no part of the present invention, the showing being merely illustrative.

The device consists of a stamping from sheet spring metal, shaped to produce a bar 20 having down-turned lateral edges 21, their rear portions provided with prongs 22, or other preferred fastening means, whereby the bar is rigidly fixed to an article, as the pen cap 17.

The extreme rear end 23 of the bar is down-turned to contact the cap, while its main front portion is convexly curved in cross section to its re-entrantly turned, width reduced front end 24, where the edges of the metal are bent inwardly to form a smooth-faced socket 25 adapted to normally contact the cap 17 under spring pressure.

Inserted in the socket is an end 28 of a spring strip 29 shaped to present transverse, wave-like undulations 30, preferably varying in size, the coarser being near the socket, while the finer gradually blend into the flattened portion 31 of the strip, which is entered between the channelled edges 21 of the bar.

It will be understood that these undulations yield readily when the clip is passed over the pocket material, as at 16, as does also the loop 25; thus the device is easy to attach in a manner to clamp the pocket material with sufficient tension to avoid accidental displacement, while the corrugations prevent side swaying movement of the article in the pocket.

In addition, the strip 29 may be further provided with non-slip means, as the fine checkered corrugations 32, shown in Figure 5, or a roughened surface 33, as in Figure 6, prior to undulating it.

Figure 7 shows a modified form of clip in which the down-turned edges 21 are provided with a series of serrations 35 as best seen in the blank of Figure 9.

A further modified form of clip is disclosed in Figure 8, in which the bar 20 is shaped to form a socket 25 at its free end to receive a strip 40 having undulations 41, the strip being free between the down-turned sides 21 of the bar and having an integral connection 42 with it at the end adjacent the prongs 22, while the opposite, free end of the strip is entered into the socket.

While certain preferred embodiments of this device have been shown and described, it will be understood that changes in the form arrangements, proportions, sizes and details thereof may be made without departing from the scope of the invention as defined in the appended claim. 5

Having thus described the invention, what is claimed as new and desired to secure by Letters Patent, is:

A pocket carried implement clip comprising a unitary spring bar having one end bent at a 10

right angle and means combined therewith for attachment to an implement, a re-entrantly in-turned loop socket at the opposite end presenting a smoothly curved under surface to contact the outer side of a pocket, a spring strip having one end abutting the inner surface of the bar angle, its opposite end being curved to engage in said loop socket, and a plurality of teeth formed transversely in said strip.

ANICETO R. VISITACION.